

Axessline QuickBox

Mounted through table top. PDU is integrated in the lid which opens with a simple press.

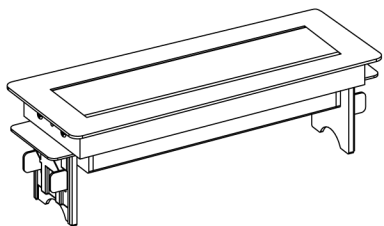

Part Check-List

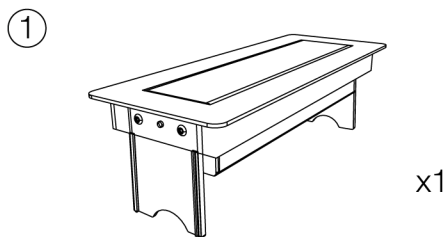

1 To install Axessline Quickbox, a cut out hole must be in place at the desired position of the table. Continue by vertically placing the box **1** inside the hole as illustrated below.

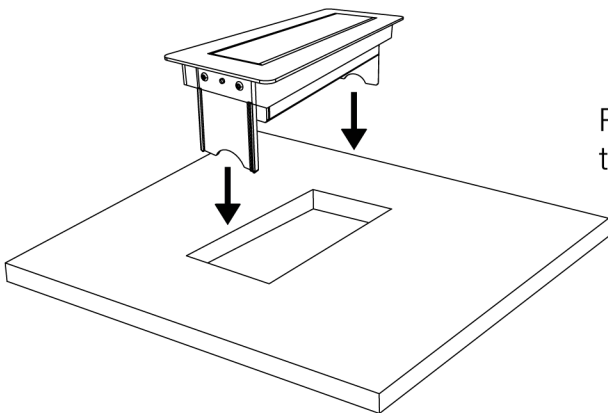

Recommended size of the cut out: 190 x 92 mm.

2 Once resting on the table, continue from below the table to ascertain its position by sliding the two clamps **2** into the tracks of its corresponding counterpart. Continue sliding them all the way to the top.

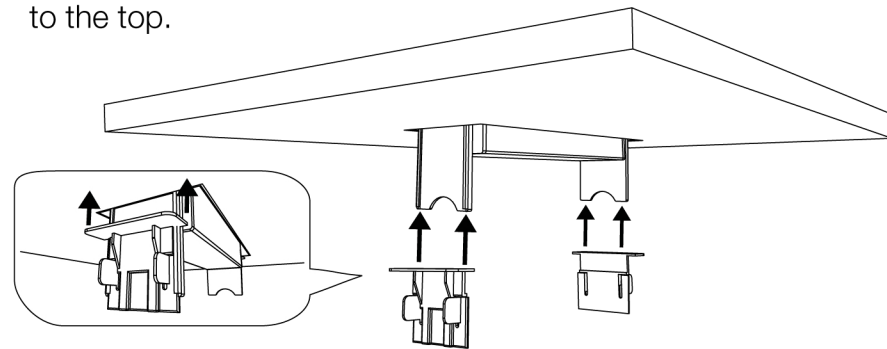

3 What remains is to provide the unit with power and finally put it to use.

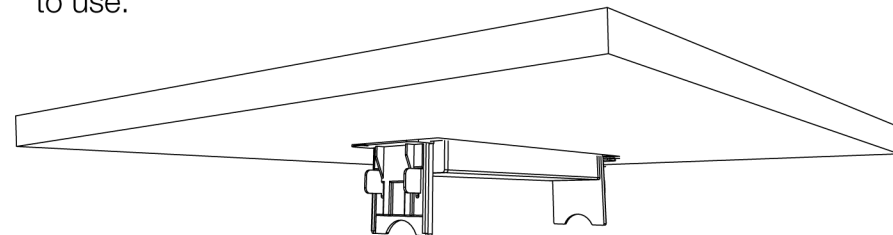

Note! To remove the clamps, pull the top part of the clamp **2** away from the box **1**. As you pull the top **1**, proceed by pulling the clamp downwards until fully removed **2**.

