

# Powerdot MICRO

## CONTENT:



x1



x1



x1

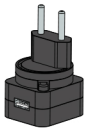

x1



x1



- 2 USB Charger  
5V, 2.0A (Type-A)

- 1450 mm USB Micro  
(Type-C Female) to  
USB (Type-A Male)  
cable

- USB (Type-A Female)  
to Europlug adapter

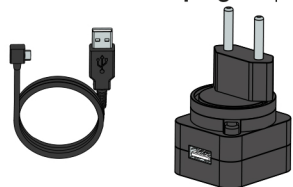

- 1** CLICK IT IN  
Place the cover on top and make sure it is aligned with the USB ports. Once aligned, push them together until it clicks.

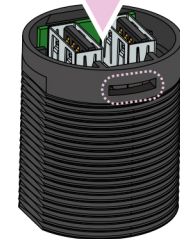
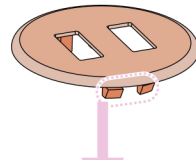

Ascertain that the by checking the side slots. If the hooks, are visible then it will not come off.

**!** Note that it is extremely difficult to remove the cover once attached without harming the product.

- 2** DRILL  
Drill a hole in the table/furniture/etc.

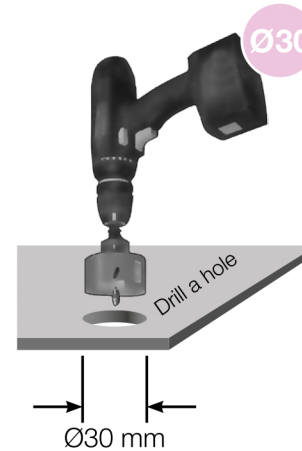

- 3** INSERT  
Insert the Powerdot MICRO into the hole, then feed the power plug through the plastic fastening nut.

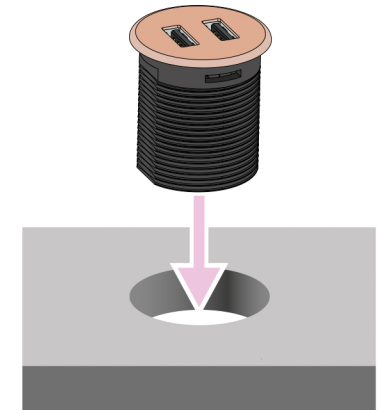

- 4** USE FASTENING NUT  
Turn the fastening nut as far up the thread as possible by turning clockwise until the product is fully rigid to the table/furniture.

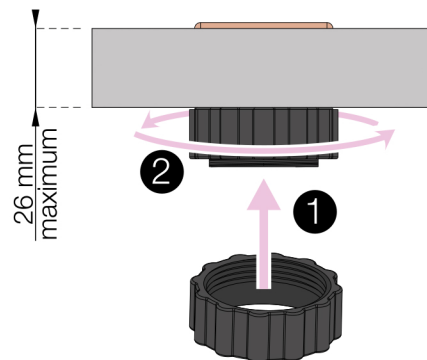

- 5** RE-ALIGN USB PORTS  
Plug the USB cable to each port to align the USB ports. Repeat for both USB ports.

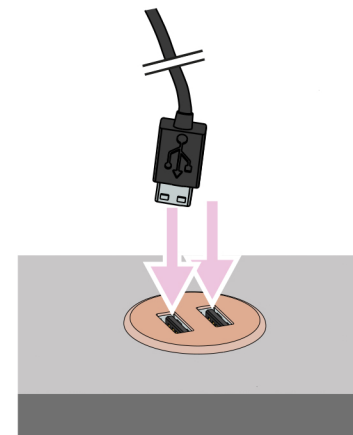

- 6** CONNECT AND PLUG IN  
Connect USB Micro cable to the grommet and to adapter. Lastly, plug it to a wall socket or powerstrip of your choice.

